

CE Mark Information for the PIO-32 Series

Note: Products that contain the CE Mark are certified to meet European EMC directive 89/336 EEC. If this directive is not of importance to your application, please disregard the information in this document.

Keithley MetraByte certifies that this product has been tested and found to be in compliance with the EMC directive and relevant harmonized standards.

This document describes the limitation of certification, the declaration of conformity, and the cabling instructions required for the CE Mark configuration.

Limitation of Certification

This certification applies only to the operation of the product (with specified cables and accessories) in the stated configuration and under the stated operational and environmental specifications. Any modification, misuse, or improper or inadequate maintenance of the product by the user voids this certification.

Any deviation from the specific configuration may cause emissions or susceptibility not within the allowed limits required by the stated directive. It is the user's responsibility to demonstrate and maintain compliance with the directive and standards.

Please read the next section, "Declaration of Conformity," for the specific testing configuration for this product. Consult the Keithley Instruments GMBH office (European importer) or Technical Support in Taunton, MA, USA, for further information regarding the exact configuration details and testing.

Declaration of Conformity

Application of Council Directive(s) 89/336/EEC
Standard(s) to which Conformity is Declared EN50081-1, EN50082-1
Manufacturer's Name Keithley MetraByte
Importer's Name Keithley Instruments GMBH
Importer's Address Landsberger Str.65 D-82110 Germering, Munich
Type of Equipment Data Acquisition Plug-in Boards
Model Numbers PIO-32IN, PIO-32OUT, PIO-32I/O with STP-37/FC, C-3200, and JACKET shield
Year of Manufacture 1995

I, the undersigned, hereby declare that the equipment specified above conforms to the above Directive(s) and Standard(s).

Place: Taunton, MA USA

(Signature)

Date: 01 January 1996

Mark Urban
(Name)

Quality Assurance Manager
(Position)

Cabling Instructions for the CE Mark Configuration

Use the C-3200 cable to connect one or more STP-37/FC accessories to a PIO-32 Series board, as shown in Figure 1. Refer to the board's user's guide for more information.

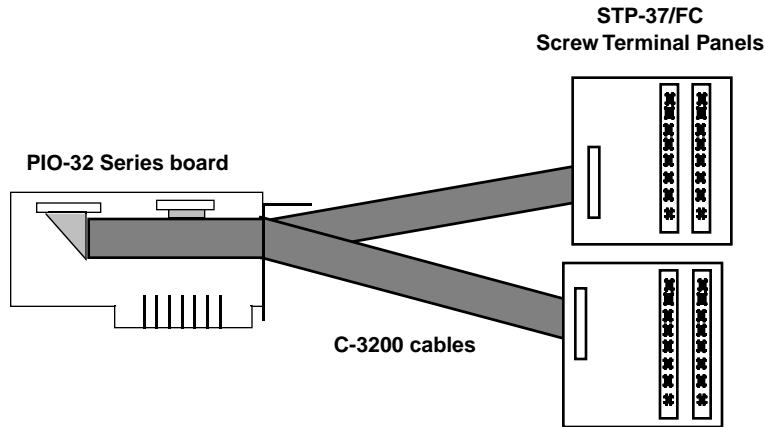

Figure 1. Attaching a PIO-32 Series Board to an STP-37/FC

For CE Mark compliance, you must shield the C-3200 cables. The procedure for shielding the cables is as follows:

1. With cabling installed and clamped, wrap all cables together with a piece of tape to mark a shield boundary at a point one-half inch or more away from the inside surface of the mounting plate, as shown in Figure 2.

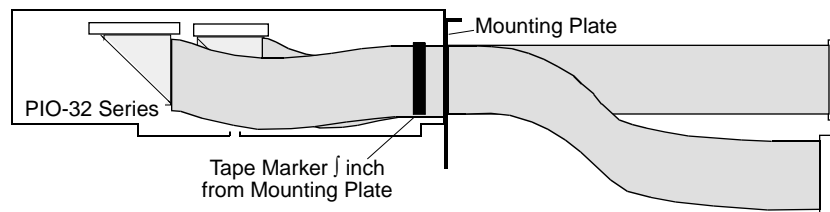

Figure 2. Cabling Taped to Show Shield Boundary

2. Remove the two clamp-adjusting screws and the clamp from the board's mounting plate.

3. Unplug the cable connectors from board, and pull the taped cabling back through the mounting plate until the tape marker is beyond the clamping area.
4. Beginning at the tape marker, cover the cabling with a single piece of jacket to the desired length, as shown in Figure 3.

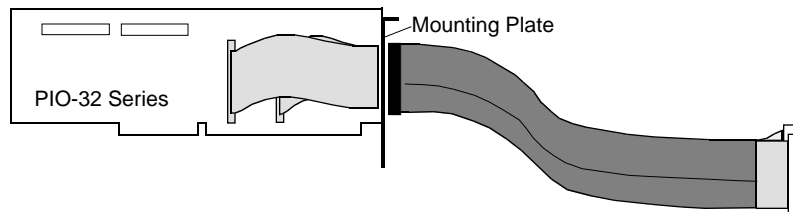

Figure 3. Cabling Wrapped with Jacket to Tape Boundary

5. Remove tape from cabling, and use scissors to cut $\frac{1}{2}$ -inch flaps in the jacket on both sides of cable, as shown in Figure 4.

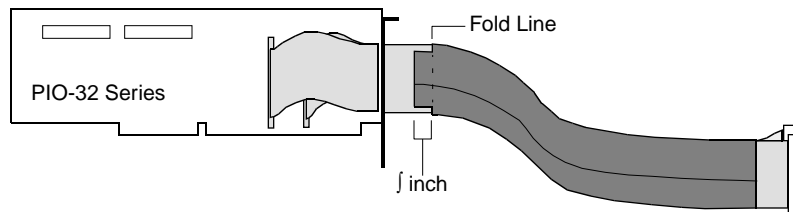

Figure 4. Jacket Trimmed with Scissors to Make $\frac{1}{2}$ -Inch Flaps

6. Fold the flaps back on both sides of cabling to expose the shield surface, as shown in Figure 5.

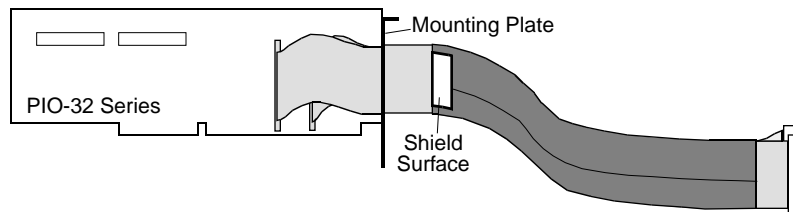

Figure 5. Jacket with Flaps Folded Back to Expose Shield Surface

7. Slide cabling back through mounting plate and plug the cable connectors back into the board, placing shield surface directly in line with mounting-plate clamp, as shown in Figure 6.

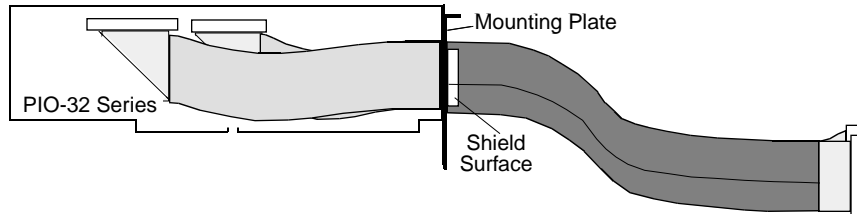

Figure 6. Cabling Reconnected, Placing Shield Surface in Line with Clamp

8. Re-install the clamp and clamp-adjusting screws so that the clamp holds the cabling firmly in place while bearing firmly on the shield surface of the jacket flap, as shown in Figure 7.

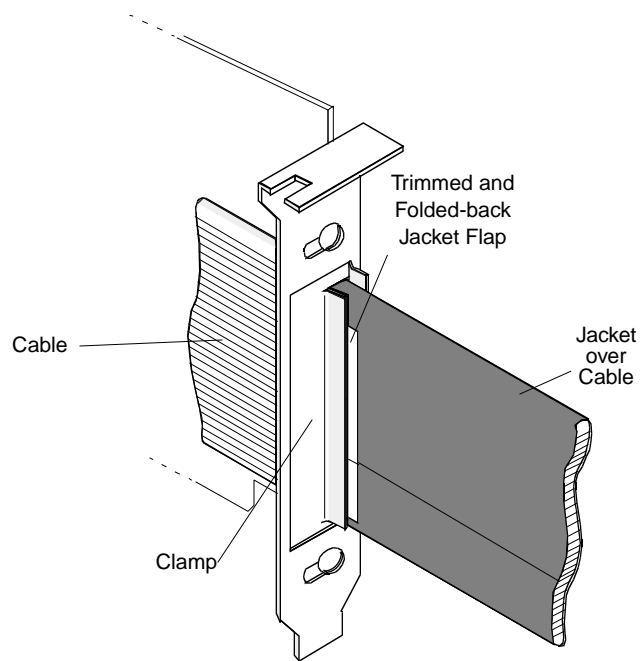

Figure 7. Detail of Clamped Cable Showing Installed Jacket